

20
1999-2019

WELDAS®

Europe B.V.



Europe Catalog No. 0219

The professional's choice world wide

Weldas® on going product development and quality control supported by field testing has earned a world wide reputation for the highest quality and most innovative products.

Weldas® products are marked with appropriate EN marking standards and are manufactured in our own, by TÜV, ISO certified factory. Most of the Weldas products are certified according to the applicable European Norms which can be found on www.weldas-ce.com. For the Russian market, EAC certificates are also available.

The pH, CHROMIUM (VI) and PCP levels of all materials in Weldas® products have been tested and meet CE health standards. Colouring is done by natural materials.

Weldas® also offers a custom designed product line for special application and marketing needs in models, packaging, barcode etc.. For more information on this contact Weldas®.

Weldas® products are warranted against manufacturing defects. Because of applications vary, it is the user's responsibility to select the right product for each application.

Weldas® is active in the following markets:

- Welding market.
- Personal protection market.
- General industrial market.

www.weldas.com



*“Global specialist
in the protection
of the welder”*

COMFOflex®

WELDING GLOVES



Cotton lining

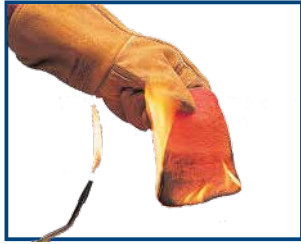

Foam lining



COMFOflex® lining

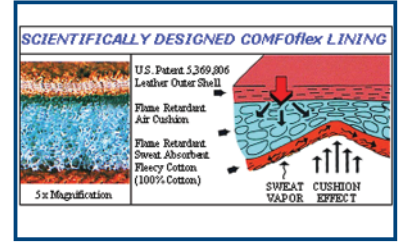

COMFOflex®

10-2000



S, L, XL, XXL
LH
L/18"

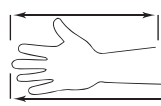

35 cm.

46 cm. (L/18")

- A-grade cow split leather
- Hand COMFOflex® lined
- Cuff cotton lined
- Wide body model
- Size L also available in Left Hand only pairs (LH) and 18" (46 cm.)



95%

KEVLAR® 4 ply + 5 ply

COMFOflex®

EN 12477 (09.2005) TYPE A
TÜV BP 60017622 0001
TÜV 21128415 002



413X3X



4133



Ω ELECTROSTATIC TESTED Ω

10-2178



L

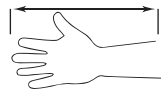

35 cm.

- Same features like the 10-2000 glove
- One finger model



95%

KEVLAR® 4 ply

COMFOflex®

EN 12477 (09.2005) TYPE A
TÜV BP 60017622 0002
TÜV 21128415 002



413X3X



4133



Ω ELECTROSTATIC TESTED Ω

10-2087



L, XL

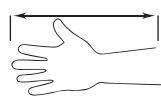

35 cm.

- A-grade cow shoulder split leather
- Hand full COMFOflex® lined
- Cuff cotton lined
- Wide body model



95%

KEVLAR® 4 ply + 5 ply

COMFOflex®

EN 12477 (09.2005) TYPE A/B
TÜV BP 60017622 0002
TÜV 21128415 002



413X3X



4133



Ω ELECTROSTATIC TESTED Ω

COMFOflex® WELDING GLOVES

10-2900



L, XL

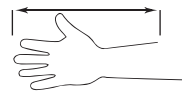

36 cm.

- A-grade cow split leather
- Hand COMFOflex® and wool lined
- Cuff flame retardant lined
- Wide body model



70%

250°C CONTACT

KEVLAR® 4 ply + 5 ply

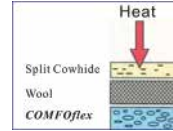

STEERSOtuff®

EN 12477 (09.2005) TYPE A
TÜV BP 60017622 0001
TÜV 21128415 002



10-2655



M, L, XL, XXL

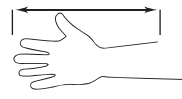

37 cm.

- Hand bison leather
- Cuff split cowhide
- Inner back of the hand COMFOflex® lined
- Cuff flame retardant lined
- **CHROMIUM < 2 mg./kg.**



30%

250°C CONTACT

KEVLAR® 4 ply + 5 ply



ThunderingBison™

EN 12477 (09.2005) TYPE A/B
TÜV BP 21146065 001
TÜV 556-10-0071/01



10-2850



L, XL

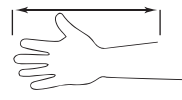

36 cm.

- Grain and split deerskin
- Backhand COMFOflex® lined and inner cuff flame retardant lined
- Highest comfort level



30%

KEVLAR® 4 ply + 5 ply



DEERSOsoft®

EN 12477 (09.2005) TYPE A/B
TÜV BP 60017622 0001
TÜV 21128415 002



COMFOflex® WELDING GLOVES

10-2750



L, XL, XXL

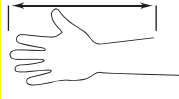

36 cm.

- A-grade cow grain leather
- Backhand **COMFOflex**® lined and cuff cotton lined
- Back palm reversed grain (suede)
- Oil and water resistant
- Excellent quality and comfortable to wear



30%

250°C CONTACT

KEVLAR® 4 ply + 5 ply



STEERSOtuff®

EN 12477 (09.2005) TYPE A/B
TÜV BP 60017622 0002
TÜV 21128415 002



Ω ELECTROSTATIC TESTED Ω

10-2755



L, XL

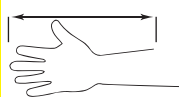

36 cm.

- Combined features:
- on the back of our 10-2385
- and the innerhand of the 10-2750 with extra comfort padges
- Oil and water resistant
- Excellent quality and comfortable to wear



30%

350°C CONTACT

KEVLAR® 4 ply + 5 ply

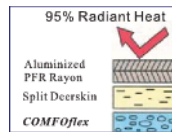

COMFOflex®

EN 12477 (09.2005) TYPE A/B
TÜV BP 60022511 0001
TÜV 21136762 003



10-2385



L, XL, XXL

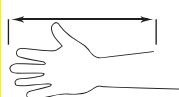

35 cm.

- A-grade cow side split leather
- Hand full **COMFOflex**® lined and cuff full flame retardant lined
- Wide body model
- Aluminized back is designed to reflect radiant heat and has a layer of split deerskin in between the back and **COMFOflex**® lining



35%

KEVLAR® 4 ply

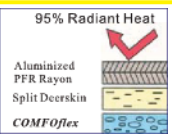

COMFOflex®

EN 12477 (09.2005) TYPE A
TÜV BP 60017622 0001
TÜV 21128415 002



+



=



44-3006LB, 44-3008LB, 44-3009BF:
see page 39

COTTON LINED WELDING GLOVES

10-2392



S, L, XL, XXL
LH/L, LH/XL

L/18"

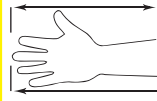

34 cm.

46 cm. (L/18)

- Cow shoulder split leather
- Full cotton lined
- Straight thumb helps the user to handle a mig gun a lot better
- Size L also available in 18" (46 cm.)
- Size L and XL also available in Left Hand only pairs (LH)



95%

KEVLAR® 3 ply

EN 12477 (09.2005) TYPE A/B
TÜV BP 60017622 0002
TÜV 21128415 002

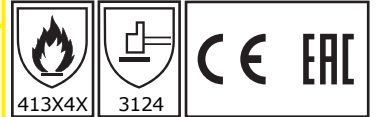

10-2392 MIT



L

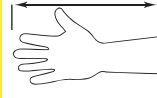

34 cm.

- One finger model of glove 10-2392
- Cow shoulder split leather
- Full cotton lined



95%

KEVLAR® 3 ply

EN 12477 (09.2005) TYPE A/B
TÜV BP 60017622 0002
TÜV 21128415 002



10-2392GB



L, XL

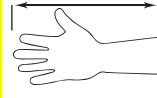

34 cm.

- Same as glove 10-2392, but *Golden Brown™* model
- Cow shoulder split leather
- Full cotton lined
- Straight thumb helps the user to handle a mig gun a lot better



95%

KEVLAR® 3 ply

EN 12477 (09.2005) TYPE A/B
TÜV BP 60017622 0002
TÜV 21128415 002



10-2150



L, XL



36 cm.

- Innerhand is made of cow grain leather to make it oil and water resistant
- All other parts of the glove are made of cow split leather
- Full cotton lined



95%

250°C CONTACT







EN 12477 (09.2005) TYPE A/B
TÜV BP 60022511 0001
TÜV 21136762 003

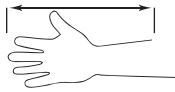

COTTON LINED WELDING GLOVES







10-2101

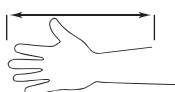

	S, L, XL, XXL LH/L, LH/XL		34 cm.
<ul style="list-style-type: none"> - The 10-2101 is our general purpose glove of the range - Cow shoulder split leather - Full cotton lined - Size L and XL also available in Left Hand only pairs (LH) 			EN 12477 (09.2005) TYPE A/B TÜV BP 60017622 0003 TÜV 21128415 002
 90%			   

10-2101GB



	L, XL		34 cm.
<ul style="list-style-type: none"> - Same as glove 10-2101, but <i>Golden Brown™</i> model - Cow shoulder split leather - Full cotton lined 			EN 12477 (09.2005) TYPE A/B TÜV BP 60017622 0003 TÜV 21128415 002
 90%			   

Weldas sizing incorporates EN 420 size standards, the lining and the intended use

(EN 420)

GLOVE AND HAND SIZE REFERENCE

Hand Size Index	7½	8½	9	9½	10½
Weldas Size Label	S	M	L	XL	XXL
Measurement mm	190	216	229	241	267
Minimum length in mm	310	320	330	340	350

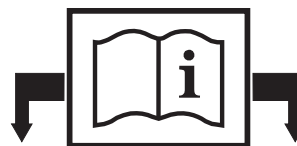
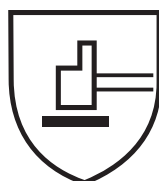
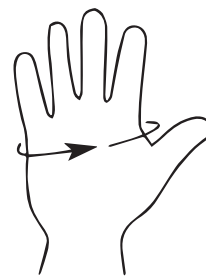

WWW.WELDAS-CE.COM

SOFTouch™ TIG WELDING GLOVES

10-1003



M, L, XL, XXL

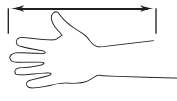

35 cm.

- Oil and abrasion resistant
- Reversed (suede) grain pig leather
- Seamless index finger

KEVLAR® 3 ply

SOFTouch™

EN 12477 (09.2005) TYPE A/B
TÜV BP 60017622 0003
TÜV 21128415 002

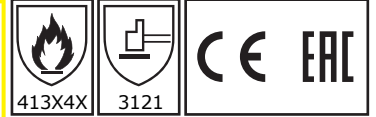

10-1004



S, M, L, XL, XXL
RH/XL

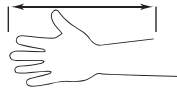

35 cm.

- Hand made of goatskin
- Double leather in the palm
- Very soft and excellent feeling
- Cuff made of grey flame retardant fabric
- Size XL also available in Right Hand only pairs (RH)

KEVLAR® 3 ply

SOFTouch™

EN 12477 (2001 + A1 : 2005)
TYPE B
TÜV BP 60118529 0001
TÜV 21264046 002

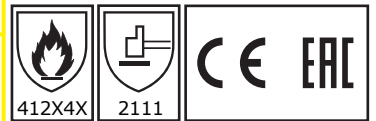

10-1005



S, M, L, XL, XXL

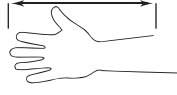

35 cm.

- Very smooth and pliable
- Calfskin grain leather
- Seamless index finger

KEVLAR® 3 ply

SOFTouch™

EN 12477 (09.2005) TYPE A/B
TÜV BP 60017622 0003
TÜV 21128415 002



Ω ELECTROSTATIC TESTED Ω

10-1007



M, L, XL

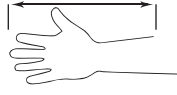

35 cm.

- Goatskin palm
- Cow split leather back and cuff

KEVLAR® 3 ply

SOFTouch™

EN 12477 (09.2005) TYPE B
TÜV BP 60017622 0003
TÜV 21128415 002



SOFTouch™

TIG WELDING GLOVES

10-1009



M, L, XL, XXL

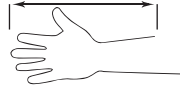

35 cm.

- Hand made of goatskin
- Very soft and excellent feeling
- Cuff made of split cow leather
- Seamless index finger

KEVLAR® 3 ply

SOFTouch™

EN 12477 (09.2005) TYPE B
TÜV BP 60017622 0004
TÜV 21128415 002



Ω ELECTROSTATIC TESTED Ω

10-1050



M, L, XL, XXL

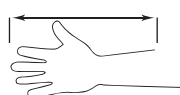

32 cm.

- Outer hand made of soft black grain cow leather
- White grain goat leather spacers on the sides of the fingers
- Curved cuff made of supple split cow leather trimmed at the edge with white grain goat leather
- Thin fleecy, flame retardant lining at the back of the hand
- Seamless index finger

KEVLAR® 4 ply

SOFTouch™

EN 12477 (2001 + A1 : 2005)
TYPE B
TÜV BP 60123577 0001
TÜV 21276706 001



10-2304



M, L, XL, XXL

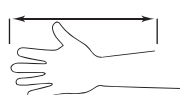

32 cm.

- Hand made of deerskin
- Very soft feeling
- Cuff made of split cow leather

KEVLAR® 3 ply



DEERSOsoft®

EN 12477 (09.2005) TYPE A/B
TÜV BP 60017622 0004
TÜV 21128415 002



10-2644



M, L, XL, XXL



32 cm.

- Hand bison leather
- Cuff split cowhide
- **CHROMIUM < 2 mg./kg.**



KEVLAR® 3 ply



ThunderingBison™

EN 12477 (09.2005) TYPE A/B
TÜV BP 21146065 001
TÜV 556-10-0071/01



WORKING GLOVES

10-2660



L, XL

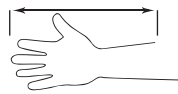

23 cm.

- Work glove designed for general purpose applications
- Grain pig leather with stretchy spandex glove back
- Wrist closable with a hook and loop closure for good fit of the glove

Not to be used in an industrial environment



10-2670



M, L, XL, XXL

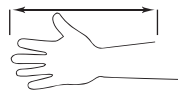

23 cm.

- Work glove designed for general purpose applications
- Grain goat leather with stretchy spandex glove back
- Wrist closable with a hook and loop closure for good fit of the glove

Not to be used in an industrial environment



10-2680



L, XL

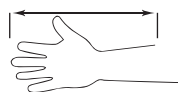

23 cm.

- Work glove designed for general purpose applications
- Grain cow leather with stretchy spandex glove back
- Wrist closable with a hook and loop closure for good fit of the glove

Not to be used in an industrial environment



10-1206



L



29 cm.

- Cow split leather
- Cotton lined
- Rubberized safety cuff

EN 388 (2016)
UL 0843-PPE-0115
UL NC29550-D1-EDO



WORKING GLOVES

10-2806



L

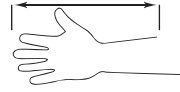

25 cm.

- Cow split leather
- Double leather in the palm
- Cotton lined
- Rubberized safety cuff

EN 388 (2016)
UL 0843-PPE-0115
UL NC29550-D1-EDO



10-2209



S, M, L, XL, XXL

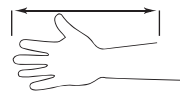

26 cm.

- A-grade cow split leather
- Cotton lined
- Rubberized safety cuff

EN 388 (2016)
UL 0843-PPE-0115
UL NC29550-D1-EDO



10-2209LB



L, XL

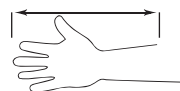

26 cm.

- A-grade cow split leather
- Cotton lined
- Rubberized safety cuff
- *Lava Brown™* model

EN 388 (2016)
UL 0843-PPE-0115
UL NC29550-D1-EDO



10-2207



L, XL



25 cm.

- Cow split leather
- Cotton lined
- Safety cuff

EN 388 (2016)
UL 0843-PPE-0115
UL NC29550-D1-EDO



DRIVER GLOVES

10-2064



L, XL

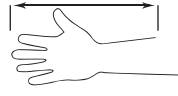

24 cm.

- Durable split cow leather

EN 388 (2016)
UL 0843-PPE-0115
UL NC29550-D1-EDO



10-2336



M, L, XL

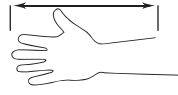

24 cm.

- Palm made of cow grain side leather
- Back made of split cow leather
- Extra fingertip sensitivity

KEVLAR® 3 ply



EN 388 (2016)
UL 0843-PPE-0115
UL NC29550-D1-EDO



10-2633



M, L, XL, XXL

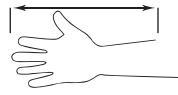

25 cm.

- Innerhand made of grain bison leather
- Back made of split cow leather
- CHROMIUM < 2 mg./kg.

KEVLAR® 3 ply



ThunderingBison™

EN 388 (2016)
UL 0843-PPE-0115
UL NC29550-D1-EDO



10-2700



S, M, L, XL, XXL

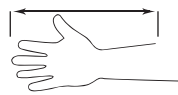

26 cm.

- Cow grain side leather of the highest quality
- Oil and water resistant



EN 388 (2016)
UL 0843-PPE-0115
UL NC29550-D1-EDO



DRIVER GLOVES

10-9334



XL

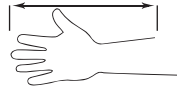

26 cm.

- Palm made of cow grain side leather
- Back made of split cow leather

EN 388 (2016)
UL 0843-PPE-0115
UL NC29550-D1-EDO



(EN 420)

GLOVE AND HAND SIZE REFERENCE

Hand Size Index	7½	8½	9	9½	10½
Weldas Size Label	S	M	L	XL	XXL
Measurement mm	190	216	229	241	267
Minimum length in mm	310	320	330	340	350

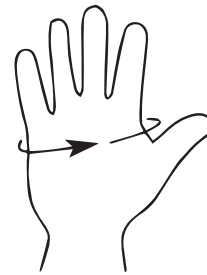

Lava Brown™ CLOTHING

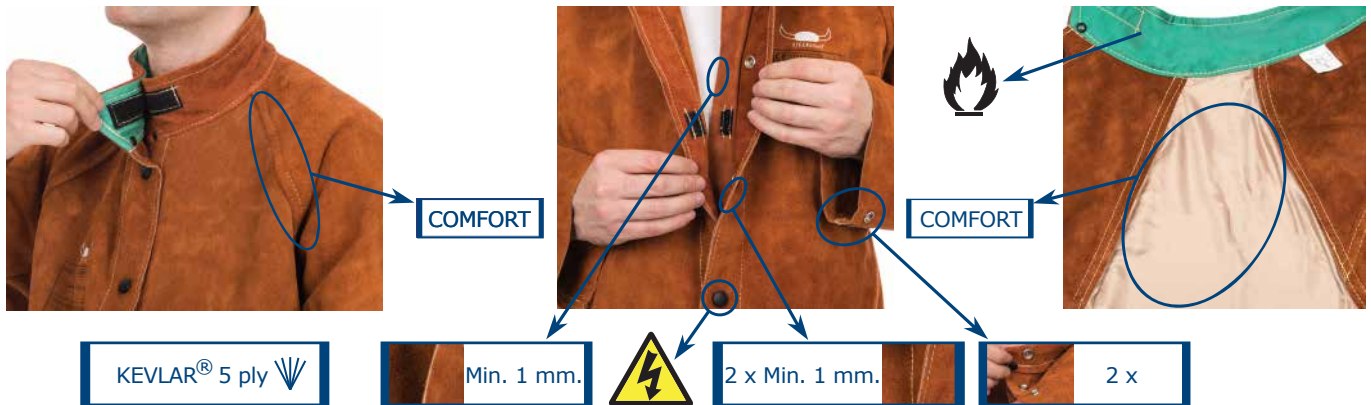

Lava Brown™ products are made of high quality A-grade side split cow leather

44-7300 Jacket full leather



- A-grade side split cow leather
- KEVLAR® 5 ply
- Leather thickness: min. 1 mm.

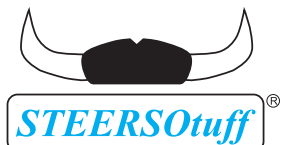

EN ISO 11611:2015
CLASS 2/A1+A2
TÜV BP 60126846 0001
TÜV 21285003 001



**EN ISO 11611:2015
CLASS 2/A1+A2**

	↑↓	↑
44-7300M	76 cm.	100 cm.
44-7300L	81 cm.	112 cm.
44-7300XL	86 cm.	124 cm.
44-7300XXL	91 cm.	136 cm.
44-7300XXXL	96 cm.	148 cm.
44-7300XXXXL	96 cm.	160 cm.

44-7300/P Jacket with flame retardant back



- A-grade side split cow leather
- KEVLAR® 5 ply
- Leather thickness: min. 1 mm.
- Back: flame retardant cotton 315 gr/m²



EN ISO 11611:2015
CLASS 1/A1+A2
TÜV BP 60127076 0001
TÜV 21280500 001



**EN ISO 11611:2015
CLASS 1/A1+A2**

	↑↓	↑
44-7300M/P	76 cm.	100 cm.
44-7300L/P	81 cm.	112 cm.
44-7300XL/P	86 cm.	124 cm.
44-7300XXL/P	91 cm.	136 cm.
44-7300XXXL/P	96 cm.	148 cm.

Lava Brown™ CLOTHING

44-7300/P-AQ Ladies jacket with flame retardant back



- A-grade side split cow leather
- KEVLAR® 5 ply
- Leather thickness: min. 1 mm.
- Back: flame retardant cotton 315 gr./m²



EN ISO 11611:2015
CLASS 1/A1+A2
TÜV BP 60127076 0001
TÜV 21280500 001



**EN ISO 11611:2015
CLASS 1/A1+A2**

	↕	
44-7300S/P-AQ	76 cm.	98 cm.
44-7300M/P-AQ	76 cm.	110 cm.
44-7300L/P-AQ	81 cm.	120 cm.
44-7300XL/P-AQ	86 cm.	130 cm.

44-7800 Cape sleeve



- A-grade side split cow leather
- KEVLAR® 5 ply
- Leather thickness: min. 1 mm.

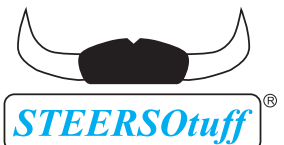

EN ISO 11611:2015
CLASS 2/A1+A2
TÜV BP 60126846 0001
TÜV 21285003 001



**EN ISO 11611:2015
CLASS 2/A1+A2**

	↕	
44-7800M	100 cm.	
44-7800L	112 cm.	
44-7800XL	124 cm.	
44-7800XXL	136 cm.	
44-7800XXXL	148 cm.	

44-78.. Apron for cape sleeves



- A-grade side split cow leather
- KEVLAR® 5 ply
- Leather thickness: min. 1 mm.



EN ISO 11611:2015
CLASS 2/A1+A2
TÜV BP 60126846 0001
TÜV 21285003 001



**EN ISO 11611:2015
CLASS 2/A1+A2**



Lava Brown™ CLOTHING

44-7248

Pants with breast protection and open back

44-7440

Pants with open back



122 cm.

- A-grade side split cow leather
- KEVLAR® 5 ply
- Leather thickness: min. 1 mm.



102 cm.



STEERSOstuff®

EN ISO 11611:2015
CLASS 2/A1+A2
TÜV BP 60126846 0001
TÜV 21285003 001



**EN ISO 11611:2015
CLASS 2/A1+A2**

44-7440/7600

Pants with closed back



- A-grade side split cow leather
- KEVLAR® 5 ply
- Leather thickness: min. 1 mm.

44-7440/7600M
44-7440/7600L
44-7440/7600XL
44-7440/7600XXL
44-7440/7600XXXL

110 cm.
112 cm.
116 cm.
122 cm.
128 cm.



STEERSOstuff®

EN ISO 11611:2015
CLASS 2/A1+A2
TÜV BP 60126846 0001
TÜV 21285003 001



**EN ISO 11611:2015
CLASS 2/A1+A2**

44-7440/7648

Pants with breast protection and closed back, bib and brace



- A-grade side split cow leather
- KEVLAR® 5 ply
- Leather thickness: min. 1 mm.

44-7440/7648M
44-7440/7648L
44-7440/7648XL
44-7440/7648XXL
44-7440/7648XXXL
44-7440/7648XXXXL

136 cm.
140 cm.
144 cm.
148 cm.
152 cm.
156 cm.



STEERSOstuff®

EN ISO 11611:2015
CLASS 2/A1+A2
TÜV BP 60126846 0001
TÜV 21285003 001



**EN ISO 11611:2015
CLASS 2/A1+A2**

Lava Brown™ CLOTHING

44-71.. Apron



- A-grade side split cow leather
- KEVLAR® 5 ply
- Leather thickness: min. 1 mm.
- Self-balancing strap system

	↕	↔
44-7124	60 cm.	60 cm.
44-7136	91 cm.	60 cm.
44-7142	107 cm.	60 cm.
44-7142 W	107 cm.	80 cm.
44-7148	122 cm.	60 cm.
44-7148 W	122 cm.	80 cm.

COMFORT



44-7124
60x60 cm.



STEERSOtuff®

EN ISO 11611:2015
CLASS 2/A1+A2
TÜV BP 60126846 0001
TÜV 21285003 001



**EN ISO 11611:2015
CLASS 2/A1+A2**

44-7023 Sleeves



- A-grade side split cow leather
- KEVLAR® 5 ply
- Leather thickness: min. 1 mm.
- Balancing strap system

44-7023

↕
58 cm.



STEERSOtuff®

EN ISO 11611:2015
CLASS 2/A1+A2
TÜV BP 60126846 0001
TÜV 21285003 001



**EN ISO 11611:2015
CLASS 2/A1+A2**

44-7028 Heavy duty arm guard (piece)



- Heavy duty
- A-grade side split cow leather
- KEVLAR® 5 ply
- Leather thickness: min. 1 mm.
- COMFOflex® lining used
- Hook and loop closure
- Inside 520 gr./m² flame retardant fabric
- See for extension 44-7114EXT (page 18)

44-7028 35 cm. 32-41 cm. 35-45 cm.



STEERSOtuff®

EN ISO 11611:2015
CLASS 2/A1+A2
TÜV BP 60126846 0001
TÜV 21285003 001



**EN ISO 11611:2015
CLASS 2/A1+A2**

Lava Brown™ CLOTHING

44-7106 Spats for shoe protection



- A-grade side split cow leather
- KEVLAR® 5 ply
- Leather thickness: min. 1 mm.
- With under the shoe an elastic strap to secure shoe top cover

44-7106

33-43 cm. 15 cm.



EN ISO 11611:2015
CLASS 2/A1+A2
TÜV BP 60126846 0001
TÜV 21285003 001



**EN ISO 11611:2015
CLASS 2/A1+A2**

44-7114 Spats for leg and shoe protection



- A-grade side split cow leather
- KEVLAR® 5 ply
- Leather thickness: min. 1 mm.
- With bendable insert at shin and shoe top to allow shape formation
- See for extension 44-7114EXT

44-7114

37-47 cm. 36 cm.



EN ISO 11611:2015
CLASS 2/A1+A2
TÜV BP 60126846 0001
TÜV 21285003 001



**EN ISO 11611:2015
CLASS 2/A1+A2**

44-7114EXT Diameter extension for 44-7114 and 44-7028



- A-grade side split cow leather
- KEVLAR® 5 ply
- Leather thickness: min. 1 mm.
- 15 cm. wide extension for 44-7114 and 44-7028

44-7114EXT + 44-7114 = 52-62 cm.

44-7114EXT

15 cm.



EN ISO 11611:2015
CLASS 2/A1+A2
TÜV BP 60126846 0001
TÜV 21285003 001



**EN ISO 11611:2015
CLASS 2/A1+A2**



COMFOflex®

SOFTouch™

DEERSOsoft®

ThunderingBison™

TURMOflex®

Lava Brown™

STEERSOtuff®

Arc Knight®

Arc Queen™

Golden Brown™

Fire Fox™

Yellowjacket®

SWEATSOpad®

COMBOframe™

LAVAshield®

PYTHONrap™

Glove Medic™

Golden Brown™ CLOTHING



KEVLAR® 3 ply ∇



Min. 1 mm.

2 x Min. 1 mm.



1 x

Golden Brown™ products are made of high quality side split or grain cow leather
Golden Brown™ split leather products: pages 20, 21, 22, 23. Grain leather products: page 24.

44-2530/P Jacket with flame retardant back



- Side split cow leather
- KEVLAR® 3 ply ∇
- Leather thickness: min. 1 mm.
- Back: flame retardant cotton 305 gr/m²

44-2530M/P
 44-2530L/P
 44-2530XL/P
 44-2530XXL/P
 44-2530XXXL/P

76 cm.	100 cm.
81 cm.	112 cm.
86 cm.	124 cm.
91 cm.	136 cm.
96 cm.	148 cm.



Golden Brown™

EN ISO 11611:2015
 CLASS 1/A1+A2
 TÜV BP 60132808 0001
 TÜV 60141016 001



**EN ISO 11611:2015
 CLASS 1/A1+A2**

44-2847 Shoulder apron



- Side split cow leather
- KEVLAR® 3 ply ∇
- Leather thickness: min. 1 mm.

44-2847M
 44-2847L
 44-2847XL

92 cm.	53 cm.
92 cm.	58 cm.
92 cm.	63 cm.



Golden Brown™

EN ISO 11611:2015
 CLASS 2/A1+A2
 TÜV BP 60132827 0001
 TÜV 60150123 001



**EN ISO 11611:2015
 CLASS 2/A1+A2**

Golden Brown™ CLOTHING

44-2800 Cape sleeve



- Side split cow leather
- KEVLAR® 3 ply √
- Leather thickness: min. 1 mm.

44-2800L
44-2800XL
44-2800XXL



112 cm.
124 cm.
136 cm.



Golden Brown™

EN ISO 11611:2015
CLASS 2/A1+A2
TÜV BP 60132827 0001
TÜV 60150123 001



**EN ISO 11611:2015
CLASS 2/A1+A2**

44-28.. Apron for cape sleeves



- Side split cow leather
- KEVLAR® 3 ply √
- Leather thickness: min. 1 mm.

44-2828
44-2836

↕ ↔
71 cm. 56 cm.
91 cm. 56 cm.



Golden Brown™

EN ISO 11611:2015
CLASS 2/A1+A2
TÜV BP 60132827 0001
TÜV 60150123 001



**EN ISO 11611:2015
CLASS 2/A1+A2**

44-21.. Apron



- Side split cow leather
- KEVLAR® 3 ply √
- Leather thickness: min. 1 mm.
- Self-balancing strap system

44-2136
44-2142
44-2142 W

↕ ↔
91 cm. 60 cm.
107 cm. 60 cm.
107 cm. 80 cm.



Golden Brown™

EN ISO 11611:2015
CLASS 2/A1+A2
TÜV BP 60132827 0001
TÜV 60150123 001



**EN ISO 11611:2015
CLASS 2/A1+A2**

Golden Brown™ CLOTHING

44-2600 Pants



- Side split cow leather
- KEVLAR® 3 ply
- Leather thickness: min. 1 mm.

44-2600M	110 cm.
44-2600L	112 cm.
44-2600XL	116 cm.



Golden Brown™

EN ISO 11611:2015
CLASS 2/A1+A2
TÜV BP 60132808 0001
TÜV 60141016 001



**EN ISO 11611:2015
CLASS 2/A1+A2**

44-2648 Pants with breast protection, bib and brace



- Side split cow leather
- KEVLAR® 3 ply
- Leather thickness: min. 1 mm.

44-2648M	136 cm.
44-2648L	140 cm.
44-2648XL	144 cm.
44-2648XXL	148 cm.



Golden Brown™

EN ISO 11611:2015
CLASS 2/A1+A2
TÜV BP 60132808 0001
TÜV 60141016 001



**EN ISO 11611:2015
CLASS 2/A1+A2**

44-2321, 44-2321XL Sleeves



- Side split cow leather
- KEVLAR® 3 ply
- Leather thickness: min. 1 mm.
- Hook and loop closure at the top
- Wrist-end with elastic band included

44-2321	52 cm.	21-31 cm.	34-47 cm.
44-2321XL	52 cm.	21-31 cm.	45-60 cm.



Golden Brown™

EN ISO 11611:2015
CLASS 2/A1+A2
TÜV BP 60132827 0001
TÜV 60150123 001



**EN ISO 11611:2015
CLASS 2/A1+A2**

Golden Brown™ CLOTHING

44-2106 Spats for shoe protection



- Side split cow leather
- KEVLAR® 3 ply
- Leather thickness: min. 1 mm.
- With under the shoe an elastic strap to secure shoe top cover

44-2106

33-43 cm. 15 cm.



Golden Brown™

EN ISO 11611:2015
CLASS 2/A1+A2
TÜV BP 60132827 0001
TÜV 60150123 001



**EN ISO 11611:2015
CLASS 2/A1+A2**

44-2114 Spats for leg and shoe protection



- Side split cow leather
- KEVLAR® 3 ply
- Leather thickness: min. 1 mm.
- With bendable insert at shin and shoe top to allow shape formation

44-2114

37-47 cm. 36 cm.



Golden Brown™

EN ISO 11611:2015
CLASS 2/A1+A2
TÜV BP 60132827 0001
TÜV 60150123 001



**EN ISO 11611:2015
CLASS 2/A1+A2**



Golden Brown™ CLOTHING



KEVLAR® 3 ply √

Min. 1 mm.

2 x Min. 1 mm.

1 x

Golden Brown™ products are made of high quality side split or grain cow leather
Golden Brown™ split leather products: pages 20, 21, 22, 23. Grain leather products: page 24.

44-5530 Jacket full leather



- Grain cow leather
- KEVLAR® 3 ply √
- Leather thickness: min. 1 mm.

44-5530L
 44-5530XL
 44-5530XXL
 44-5530XXXL

	81 cm.	112 cm.
	86 cm.	124 cm.
	91 cm.	136 cm.
	96 cm.	148 cm.



EN ISO 11611:2015
 CLASS 2/A1+A2
 TÜV BP 60132801 0001
 TÜV 60140939 001



**EN ISO 11611:2015
 CLASS 2/A1+A2**

44-5600 Pants with breast protection, bib and brace



- Grain cow leather
- KEVLAR® 3 ply √
- Leather thickness: min. 1 mm.

44-5600L
 44-5600XL
 44-5600XXL
 44-5600XXXL

	140 cm.
	144 cm.
	148 cm.
	152 cm.



EN ISO 11611:2015
 CLASS 2/A1+A2
 TÜV BP 60132801 0001
 TÜV 60140939 001



**EN ISO 11611:2015
 CLASS 2/A1+A2**

Yellowjacket® CLOTHING



KEVLAR® 3 ply ✓



Min. 1 mm.

305 gr./m²



1 x

Yellowjacket® product is made of 305 gr./m² flame retardant cotton body and split cow leather sleeves

33-3060 Jacket, flame retardant cotton with leather sleeves



- 305 gr./m² flame retardant cotton body
- split cow leather sleeves
- KEVLAR® 3 ply ✓

Yellowjacket®

EN ISO 11611:2015
CLASS 1/A1+A2
TÜV BP 60132808 0001
TÜV 60141016 001

	↕	
33-3060S	76 cm.	108 cm.
33-3060M	76 cm.	116 cm.
33-3060L	81 cm.	127 cm.
33-3060XL	86 cm.	138 cm.
33-3060XXL	91 cm.	147 cm.
33-3060XXXL	96 cm.	158 cm.
33-3060XXXXL	96 cm.	168 cm.



**EN ISO 11611:2015
CLASS 1/A1+A2**



Arc Knight® CLOTHING



KEVLAR® 3 ply √



520 gr./m²



Double material



1 x

Arc Knight® 38-4350, 38-4355, 38-44.. and 38-4340 are made of heavy duty 520 gr./m² FR cotton with split cow leather reinforcement.

Arc Knight® 38-4330, 38-4335, 38-4375, 38-4328, 38-43.., 38-4360 and 38-4321XL are made of heavy duty 520 gr./m² FR cotton.

38-4350 Jacket with leather reinforcement



- High comfort and flexibility
- Heavy duty 520 gr./m² FR cotton with black split cow leather reinforcement
- KEVLAR® 3 ply √
- Sleeve with double closure



Arc Knight®

EN ISO 11611:2015
CLASS 2/A1+A2
TÜV BP 60122567 0001
TÜV 21260757 003



EN ISO 11611:2015
CLASS 2/A1+A2

	76 cm.	96 cm.
38-4350M	81 cm.	104 cm.
38-4350L	86 cm.	112 cm.
38-4350XL	91 cm.	120 cm.
38-4350XXL	96 cm.	128 cm.

38-4330 Jacket



44-7820
44-7828
44-7836
44-7836XL
(see page 15)



38-4320
(see page 28)

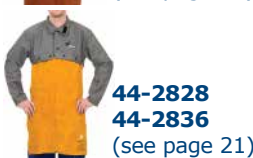

44-2828
44-2836
(see page 21)

- High comfort and flexibility
- Heavy duty 520 gr./m² FR cotton
- KEVLAR® 3 ply √
- Possibility to add a *Lava Brown™* or *Golden Brown™* apron to this jacket



Arc Knight®

EN ISO 11611:2015
CLASS 2/A1+A2
TÜV BP 60122567 0001
TÜV 21260757 003



EN ISO 11611:2015
CLASS 2/A1+A2

	76 cm.	96 cm.
38-4330M	81 cm.	104 cm.
38-4330L	86 cm.	112 cm.
38-4330XL	91 cm.	120 cm.
38-4330XXL	96 cm.	128 cm.

Arc Knight® CLOTHING

38-4335 Jacket, high visibility



- High visibility
- High comfort and flexibility
- Heavy duty 520 gr./m² FR cotton
- KEVLAR® 3 ply √
- Available in size: M, L, XL, XXL, XXXL

NEW

38-4355 Jacket, high visibility



Arc Knight®



EN ISO 11611:2015
CLASS 2/A1+A2
EN ISO 20471:2013
+ A1:2016 clause 6
TÜV BP 60122567 0003
TÜV 21260757 003

38-4375 Lab coat



- High comfort and flexibility
- Heavy duty 520 gr./m² FR cotton
- KEVLAR® 3 ply √

38-4375M
38-4375L
38-4375XL
38-4375XXL

	114 cm.	96 cm.
	114 cm.	104 cm.
	114 cm.	112 cm.
	114 cm.	120 cm.



Arc Knight®

EN ISO 11611:2015
CLASS 2/A1+A2
TÜV BP 60122567 0001
TÜV 21260757 003



EN ISO 11611:2015
CLASS 2/A1+A2

38-4328 Cape sleeve



- High comfort and flexibility
- Heavy duty 520 gr./m² FR cotton
- KEVLAR® 3 ply √

38-4328M
38-4328L
38-4328XL
38-4328XXL
38-4328XXXL



96 cm.
104 cm.
112 cm.
120 cm.
128 cm.



Arc Knight®

EN ISO 11611:2015
CLASS 2/A1+A2
TÜV BP 60122567 0001
TÜV 21260757 003



EN ISO 11611:2015
CLASS 2/A1+A2

Arc Knight® CLOTHING

38-4320 Apron for cape sleeve



- High comfort and flexibility
- Black split cow leather
- KEVLAR® 3 ply

38-4320

51 cm.

56 cm.



Arc Knight®

EN ISO 11611:2015
CLASS 2/A1+A2

TÜV BP 60122567 0001
TÜV 21260757 003



EN ISO 11611:2015
CLASS 2/A1+A2

38-43.. Apron



- High comfort and flexibility
- Heavy duty 520 gr./m² FR cotton
- KEVLAR® 3 ply
- Self-balancing strap system

38-4336

91 cm.

60 cm.

38-4342

107 cm.

60 cm.

38-4342 W

107 cm.

80 cm.

COMFORT



Arc Knight®

EN ISO 11611:2015
CLASS 2/A1+A2

TÜV BP 60122567 0001
TÜV 21260757 003



EN ISO 11611:2015
CLASS 2/A1+A2

38-44.. Apron with leather reinforcement



- High comfort and flexibility
- Heavy duty 520 gr./m² FR cotton with black split cow leather reinforcement
- KEVLAR® 3 ply
- Self-balancing strap system

38-4436

91 cm.

60 cm.

38-4442

107 cm.

60 cm.

38-4442 W

107 cm.

80 cm.

COMFORT



Arc Knight®

EN ISO 11611:2015
CLASS 2/A1+A2

TÜV BP 60122567 0001
TÜV 21260757 003



EN ISO 11611:2015
CLASS 2/A1+A2

Arc Knight® CLOTHING

38-4360 Pants



- High comfort and flexibility
- Heavy duty 520 gr./m² FR cotton
- KEVLAR® 3 ply
- Possibility to add knee pads

38-4360M
38-4360L
38-4360XL
38-4360XXL



79 cm.
81 cm.
83 cm.
85 cm.



Arc Knight®

EN ISO 11611:2015
CLASS 2/A1+A2
TÜV BP 60122567 0001
TÜV 21260757 003



EN ISO 11611:2015
CLASS 2/A1+A2

38-4340 Pants with leather reinforcement, breast protection, bib and brace



- High comfort and flexibility
- Heavy duty 520 gr./m² FR cotton with black split cow leather reinforcement
- KEVLAR® 3 ply

38-4340M
38-4340L
38-4340XL
38-4340XXL
38-4340XXXL



136 cm.
140 cm.
144 cm.
148 cm.
152 cm.



Arc Knight®

EN ISO 11611:2015
CLASS 2/A1+A2
TÜV BP 60122567 0001
TÜV 21260757 003



EN ISO 11611:2015
CLASS 2/A1+A2

38-4321XL Sleeves



- High comfort and flexibility
- Heavy duty 520 gr./m² FR cotton
- KEVLAR® 3 ply

38-4321XL



52 cm.



21-31 cm.



45-60 cm.



Arc Knight®

EN ISO 11611:2015
CLASS 2/A1+A2
TÜV BP 60122567 0001
TÜV 21260757 003



EN ISO 11611:2015
CLASS 2/A1+A2

Fire Fox™ CLOTHING

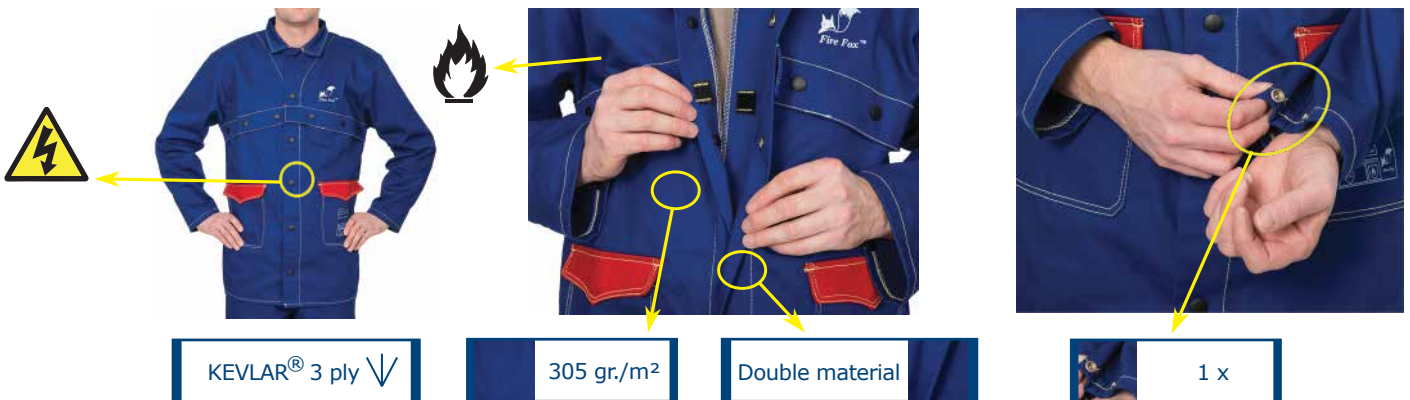

KEVLAR® 3 ply √

305 gr./m²

Double material

1 x

Fire Fox™ clothing is made of 305 gr./m² flame retardant cotton

33-2300 Jacket



44-7820
44-7828
44-7836
44-7836XL
(see page 15)

44-2828
44-2836
(see page 21)

- 305 gr./m² flame retardant cotton
- KEVLAR® 3 ply √
- Possibility to add a *Lava Brown™* or *Golden Brown™* apron to this jacket



33-2300M	76 cm.	96 cm.
33-2300L	81 cm.	104 cm.
33-2300XL	86 cm.	112 cm.
33-2300XXL	91 cm.	120 cm.
33-2300XXXL	96 cm.	128 cm.



Fire Fox™

EN ISO 11611:2007
CLASS 1/A1+A2
TÜV BP 60097781 0001
TÜV 21220109 002



**EN ISO 11611:2007
CLASS 1/A1+A2**

33-2600 Pants



- 305 gr./m² flame retardant cotton
- KEVLAR® 3 ply √
- Possibility to add knee pads



33-2600M	79 cm.
33-2600L	81 cm.
33-2600XL	83 cm.
33-2600XXL	85 cm.
33-2600XXXL	87 cm.



Fire Fox™

EN ISO 11611:2007
CLASS 1/A1+A2
TÜV BP 60097781 0001
TÜV 21220109 002



**EN ISO 11611:2007
CLASS 1/A1+A2**

Fire Fox™ CLOTHING

33-2700 Pants with breast protection, bib and brace



- 305 gr./m² flame retardant cotton
- KEVLAR® 3 ply
- Possibility to add knee pads

33-2700M
33-2700L
33-2700XL
33-2700XXL
33-2700XXXL



79 cm.
81 cm.
83 cm.
85 cm.
87 cm.



Fire Fox™

EN ISO 11611:2007
CLASS 1/A1+A2
TÜV BP 60097781 0001
TÜV 21220109 002



**EN ISO 11611:2007
CLASS 1/A1+A2**

33-2800 Coverall



- 305 gr./m² flame retardant cotton
- KEVLAR® 3 ply
- Possibility to add knee pads

33-2800M
33-2800L
33-2800XL
33-2800XXL
33-2800XXXL



176 cm.
180 cm.
184 cm.
188 cm.
196 cm.



Fire Fox™

EN ISO 11611:2007
CLASS 1/A1+A2
TÜV BP 60097781 0001
TÜV 21220109 002



**EN ISO 11611:2007
CLASS 1/A1+A2**

33-2320 Sleeves

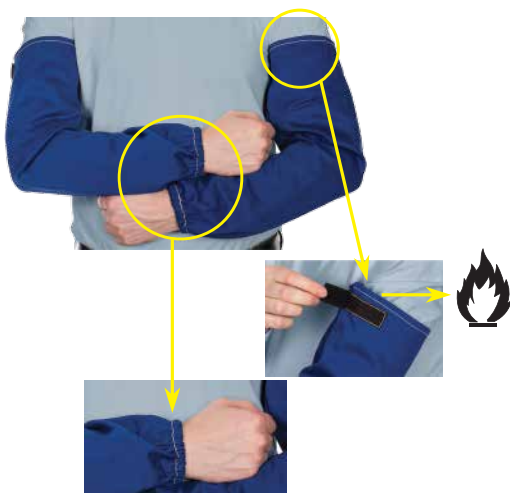

- 305 gr./m² flame retardant cotton
- KEVLAR® 3 ply

33-2320



52 cm.



19-32 cm.



36-47 cm.



Fire Fox™

EN ISO 11611:2007
CLASS 1/A1+A2
TÜV BP 60097781 0001
TÜV 21220109 002



**EN ISO 11611:2007
CLASS 1/A1+A2**

Fire Fox™

FR COTTON CAPS

23-*514 FR Cap



Fire Fox™

EN ISO 11611:2007
CLASS 1/A1+A2
TÜV BP 60097781 0002
TÜV 21220109 002



**EN ISO 11611:2007
CLASS 1/A1+A2**

23-*515 FR Cap



COMFORT



**Choose the best size for all caps:
* = 1, 2, 3, 4, 5, 6, 7**

Size	Articlenumber	
7	23-1xxx	56 cm.
7 1/8	23-2xxx	57 cm.
7 1/4	23-3xxx	58 cm.
7 3/8	23-4xxx	59 cm.
7 1/2	23-5xxx	60 cm.
7 5/8	23-6xxx	61 cm.
7 3/4	23-7xxx	62 cm.

COTTON CAPS

23-*503 Camouflage



23-*507 USA flag



23-*524 Wild



Fire Fox™

FR BEANIE

23-8000 FR Beanie



- Often used in combination with helmet
- High comfort and flexibility
- 305 gr./m² flame retardant cotton



Fire Fox™

EN ISO 11611:2007
CLASS 1/A1+A2
TÜV BP 60097781 0002
TÜV 21220109 002



**EN ISO 11611:2007
CLASS 1/A1+A2**

23-8000L 56-59 cm. 
23-8000XL 59-62 cm.

Fire Fox™

FR COTTON DOO-RAGS

23-3612 FR Doo-Rag



23-3613 FR Doo-Rag



Fire Fox™

EN ISO 11611:2007
CLASS 1/A1+A2
TÜV BP 60097781 0002
TÜV 21220109 002



**EN ISO 11611:2007
CLASS 1/A1+A2**

23-3611 FR Doo-Rag



23-3615 FR Doo-Rag



- Often used in combination with helmet
- High comfort and flexibility
- Sweatband integrated in the front of the Doo-Rag
- 305 gr./m² flame retardant cotton

All Doo-Rags, one size fits all:

46-68 cm.

COTTON DOO-RAGS

23-3601 Camouflage



23-3602 Wild



23-3604 USA flag



23-3606 Happy Hour



23-3607 Paradise



23-3609 European flag



Fire Fox™

FR HELMET HOODS

23-6680, 23-6680XL

23-6680/LV

23-6690



- Connectable to helmet gear
- Hook and loop closure
- 305 gr./m² flame retardant cotton



Fire Fox™

EN ISO 11611:2007
CLASS 1/A1+A2
TÜV BP 60097781 0002
TÜV 21220109 002



**EN ISO 11611:2007
CLASS 1/A1+A2**

23-6680 / 23-6680LV / 23-6690: 64 cm.
23-6680XL: 68 cm.

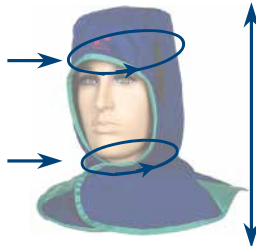

23-6680: 41 cm.
23-6690: 41 cm.
23-6680XL: 44 cm.
23-6680/LV: 62 cm.

23-6680 / 23-6680LV / 23-6690: 42 - 53 cm.
23-6680XL: 52 - 65 cm.

Multiple sizes and lengths

Arc Knight®

LEATHER HELMET HOOD

23-6630



- Hook and loop closure
- Black split cow leather with 520 gr./m² flame retardant cotton
- Available in size L and XL
- KEVLAR® 3 ply



EN ISO 11611:2015
CLASS 2/A1+A2
TÜV BP 60133477 0001
TÜV 60142905 001



**EN ISO 11611:2015
CLASS 2/A1+A2**

NEW



TURMOflex®

WINTER HELMET LINERS

23-7766



- Connectable to helmet gear
- Hook and loop closure
- 305 gr./m² flame retardant cotton
- COMFOflex® lining



TURMOflex®

EN ISO 11611:2015
CLASS 2/A1
TÜV BP 60133478 0001
TÜV 60142984 001



**EN ISO 11611:2015
CLASS 2/A1**

23-7711



before
washed

23-7701



23-7702



23-7733



"Most comfortable sweatband in the world"

AIR CUSHIONED
SWEATSpad[®]

SWEATSpad[®]



SWEATSOpad®

HELMET COMFORTER

- Helmet pad and sweatband combined in one piece air cushioned *SWEATSOpad*®
- Flame retardant
- No more "helmet head"!
- No more slippage!
- No more sweat!

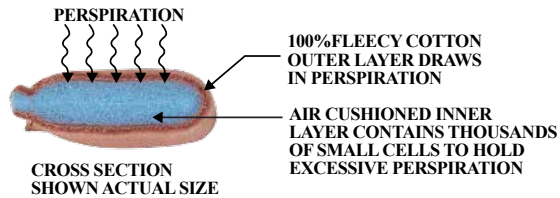

20-3100V, 20-3100V/17



5 x

20-3100V 22 cm.
20-3100V/17 17 cm.

SWEATSOpad®

EN ISO 11611:2003
CLAUSE 6.6
TÜV AK 60013119 0001
TÜV 21120493 001



20-3200V



5 x

20-3200V 25 cm.

SWEATSOpad®

EN ISO 11611:2003
CLAUSE 6.6
TÜV AK 60013119 0001
TÜV 21120493 001



20-3300V



5 x

20-3300V 14 cm.

SWEATSOpad®

EN ISO 11611:2003
CLAUSE 6.6
TÜV AK 60013119 0001
TÜV 21120493 001



LEATHER HELMET CAPS AND BIBS

44-7180



- Grain leather helmet cap
- Black grain pigskin
- Will fit over the helmet gear and can be attached with hook and loop to the top of the helmet gear.

44-7181



- Grain leather back neck protection
- Black grain pigskin
- Made to be attached with hook and loop to the cap (= art.nr. 44-7180)

- Dimensions:

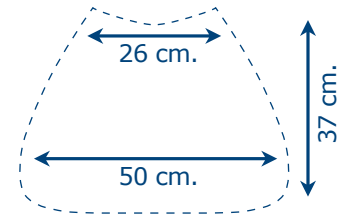

44-7182



- Grain leather front neck protection
- Black grain pigskin
- Can be attached with hook and loop to the helmet inside or outside

- Dimensions:

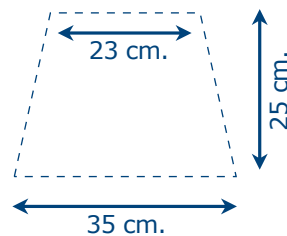

44-7184



- Split leather Front neck protection
- Black split cowhide
- Can be attached with hook and loop to the helmet inside or outside

- Dimensions:

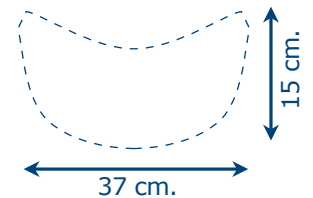

ACCESSORIES

44-7111



- Foldable inspector mask
- Fits glass: 110 x 50 mm.
- Glass not included

KEVLAR® 3 ply √



16 cm.

44-7110



- Electrode bag with hanging system
- To be filled with max. 2 kg. electrodes
- Double leather construction

KEVLAR® 3 ply √

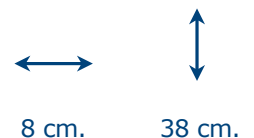

8 cm.

38 cm.

ACCESSORIES

44-3006LB, 44-3006LB/PR



- High heat reflective handshield
- Split cowhide leather back with **aluminized PFR front**
- Also available in pairs (44-3006LB/PR)

EN 532
TÜV 744-800515/25

KEVLAR® 5 ply

15 cm. 20 cm.



44-3008LB



- High heat reflective handshield
- Split cowhide leather back with **fiber glass front**
- Extra heat resistant

15 cm. 20 cm.

KEVLAR® 5 ply

44-3009BF



- High heat reflective handshield
- **Black coated fiber glass back with fiber glass front**
- Heavy duty handshield for the toughest applications

15 cm. 20 cm.

KEVLAR® 5 ply

10-1099



- TIG finger
- For extra protection
- For extra stability in position welding
- Silica fabric
- With hook and loop

KEVLAR® 3 ply

3,5 cm. 16 cm.

10-1911/UL



- **10-1911/UL**
Repair & reinforcement kit for unlined gloves such as TIG welding, drivers and mechanic gloves.



- **10-2911/LI**
Repair & reinforcement kit for lined gloves such as stick or MIG welders, heavy duty work, heat resistant gloves.

Caution: For certified gloves, check ratings before operation. For non-certified gloves, owner is responsible to ensure proper protection before operation.

10-2911/LI



WELDING PILLOWS



44-7900



- 50 x 50 x 8 cm.
- KEVLAR® 3 ply



44-7905



- 39 x 33 x 3 cm.
- KEVLAR® 3 ply

44-7910



- 50 x 50 x 8 cm.
- KEVLAR® 3 ply



44-7915



- 39 x 33 x 3 cm.
- KEVLAR® 3 ply

44-7920



- 50 x 50 x 8 cm.
- KEVLAR® 3 ply



44-7925



- 39 x 33 x 3 cm.
- KEVLAR® 3 ply

PYTHONrap™ CABLE COVERS

T = Tube



44-xxxxT

44-1022T	22 mm dia	1 m length lightbrown leather cable cover
44-1027T	27 mm dia	1 m length lightbrown leather cable cover

V = Hook and loop



44-xxxxV

44-0550V	50 mm dia	5 m length lightbrown leather cable cover
44-1050V	50 mm dia	10 m length lightbrown leather cable cover

44-5030V/MTR	30 mm dia	Lightbrown leather cable cover PER METER
		1 roll = 50 mtr.
44-5050V/MTR	50 mm dia	Lightbrown leather cable cover PER METER
		1 roll = 50 mtr.

Z = Zipper



44-xxxxZ

44-3001Z	22 mm dia	1 m length lightbrown leather cable cover
44-3010Z	22 mm dia	3 m length lightbrown leather cable cover
44-3022Z	22 mm dia	6,7 m length lightbrown leather cable cover
44-3922Z	22 mm dia	3,9 m length lightbrown leather cable cover
44-3928Z	28 mm dia	3,9 m length lightbrown leather cable cover
44-7922Z	22 mm dia	7,9 m length lightbrown leather cable cover
44-7928Z	28 mm dia	7,9 m length lightbrown leather cable cover
44-4001Z	32 mm dia	1 m length lightbrown leather cable cover
44-4525Z	37 mm dia	2,5 m length lightbrown leather cable cover
44-4535Z	37 mm dia	3,5 m length lightbrown leather cable cover



44-xxxxZ

44-3601Z	22 mm dia	1 m length black grain leather cable cover
44-3628Z	28 mm dia	1 m length black grain leather cable cover



44-xxxxZ

44-4023Z	23 mm dia	4 m length black flame retardant nylon cable cover
44-4028Z	28 mm dia	4 m length black flame retardant nylon cable cover
44-8023Z	23 mm dia	8 m length black flame retardant nylon cable cover
44-8028Z	28 mm dia	8 m length black flame retardant nylon cable cover

KEVLAR® 3 ply

Other length / diameter combinations on request

LAVAsield® WELDING BLANKETS

50-1866

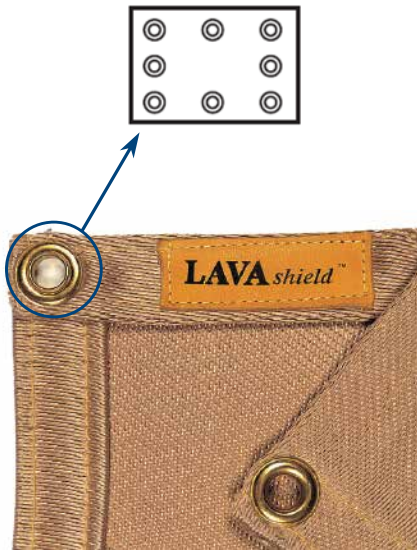

50-2368/2468



50-3068



- Silica fabric
- 174 x 174 cm.
- ± 1000°C
- ± 600 gr./m²
- KEVLAR® 3 ply ↓

- Black fiberglass
- Neoprene / neoprene coating
- 174 x 234 cm.
- ± 550°C
- ± 800 gr./m²
- KEVLAR® 3 ply ↓

- Gold fiberglass
- Acryl / neoprene coating
- 174 x 234 cm.
- ± 550°C
- ± 1000 gr./m²
- KEVLAR® 3 ply ↓

50-2472 Per meter



- Black fiberglass
- Neoprene / neoprene coating
- Not locked stitched
- Without grommets
- Width ± 183 cm.
- Total roll length ± 45 mtr.
- ± 550°C
- ± 800 gr./m²

LAVAsield®

ISO 9150:1988-12

TÜV 21278287 001



50-3072 Per meter



- Gold fiberglass
- Acryl / neoprene coating
- Not locked stitched
- Without grommets
- Width ± 183 cm.
- Total roll length ± 45 mtr.
- ± 550°C
- ± 1000 gr./m²



LAVAsield® WELDING SCREENS

55-6166 Orange/Red 1.74 x 1.74 mtr.



Fits within frame 1.8 x 1.8 mtr.

- Heat sealed seams and grommets
- Nylon ties are furnished for convenience and secure fastening to the quick connection Weldas® *COMBOframe*™: 55-8668



28 pcs. plastic grommets

LAVAsield®

DIN EN ISO 25980:2015-01
13821-PZA-17



55-6168 Orange/Red 1.74 x 2.34 mtr.



Fits within frame 1.8 x 2.4 mtr.

- Heat sealed seams and grommets
- Nylon ties are furnished for convenience and secure fastening to the quick connection Weldas® *COMBOframe*™: 55-8668



32 pcs. plastic grommets

LAVAsield®

DIN EN ISO 25980:2015-01
13821-PZA-17



55-7166 Green 1.74 x 1.74 mtr.



Fits within frame 1.8 x 1.8 mtr.

- Heat sealed seams and grommets
- Nylon ties are furnished for convenience and secure fastening to the quick connection Weldas® *COMBOframe*™: 55-8668



28 pcs. plastic grommets

LAVAsield®

DIN EN ISO 25980:2015-01
13822-PZA-17



55-7168 Green 1.74 x 2.34 mtr.



Fits within frame 1.8 x 2.4 mtr.

- Heat sealed seams and grommets
- Nylon ties are furnished for convenience and secure fastening to the quick connection Weldas® *COMBOframe*™: 55-8668



32 pcs. plastic grommets

LAVAsield®

DIN EN ISO 25980:2015-01
13822-PZA-17



COMBOframe™ MODULAR FRAME

55-8668

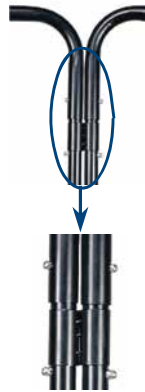
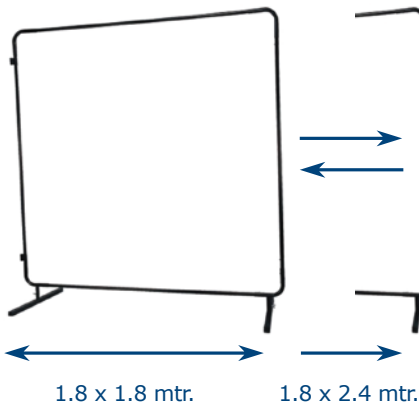

55-8668

1.8 x 1.8 mtr. / 1.8 x 2.4 mtr.

- Weldas® COMBOframe™ suitable for the welding screens: 55-6166, 55-6168, 55-7166, 55-7168
- Will be delivered as only frame (incl. swivelset), without screens

COMBOframe™



LAVashield® WELDING SCREENS PER METER

55-6166/MTR Orange/Red



- Heat sealed seam and grommets at one side
- Distance between grommets ± 20 cm.
- Will be delivered together with rings Ø 50 mm.
- Height ± 1.78 mtr.
- Total roll length ± 27 mtr.

LAVashield®

DIN EN ISO 25980:2015-01
13821-PZA-17

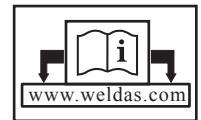

55-7166/MTR Green

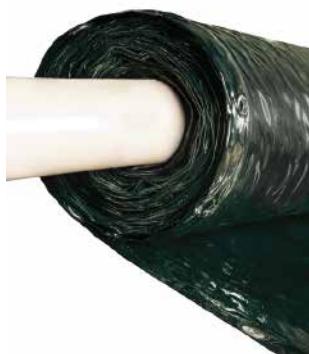

- Heat sealed seam and grommets at one side
- Distance between grommets ± 20 cm.
- Will be delivered together with rings Ø 50 mm.
- Height ± 1.78 mtr.
- Total roll length ± 27 mtr.

LAVashield®

DIN EN ISO 25980:2015-01
13822-PZA-17



LAVAshield®

ECONO STRIP SCREENS

55-6166/Strip Orange/Red



0.68 x 1.8 mtr.

- Will be delivered together with 5 rings Ø 50 mm.



LAVAshield®

DIN EN ISO 25980:2015-01
13821-PZA-17

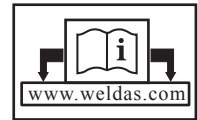

55-7166/Strip Green



0.68 x 1.8 mtr.

- Will be delivered together with 5 rings Ø 50 mm.



LAVAshield®

DIN EN ISO 25980:2015-01
13822-PZA-17



LAVAshield®

CONNECTABLE WELDING SCREENS

55-6218 Orange/Red



1.37 x 1.8 mtr.

- Connectable welding screen
- Heat sealed seams
- Will be delivered together with 9 rings Ø 50 mm.



LAVAshield®

DIN EN ISO 25980:2015-01
13821-PZA-17

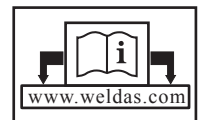

55-7218 Green



1.37 x 1.8 mtr.

- Connectable welding screen
- Heat sealed seams
- Will be delivered together with 9 rings Ø 50 mm.



LAVAshield®

DIN EN ISO 25980:2015-01
13822-PZA-17

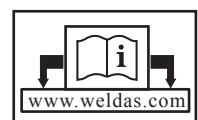

SELECTION CRITERIA

In order to make the right choice in a type and/or model of a personal protection product the user should make for himself selection criteria in order to come up with the best choice for his/her situation.

Weldas wants to help with that by giving you a number of selection criteria to start by making the right choice. Please read for that the 2 following pages carefully.

General selection criteria for leather products such as welding gloves and welding clothing

Choosing the right product is always important to make the workplace productive but also safe.

The factors to consider include one or more of the following arguments:

- Protection arguments: resistant to heat, flame, molten splashes, UV, electricity and punctures.
- Health arguments: values of pH, Chromium, PCP or other substances that needs to be within limits.
- Durability arguments: values of abrasion resistance, tensile strength, tear resistance, heat related dimensional change resistance, reinforced seams and stress points as well as thread strength and flame resistance.
- Comfort arguments: the right sizing and fit, dexterity, fingertip sensitivity, weight, sweat vapor transmission and absorption and climate and oil resistant.

Type of leather selection criteria for leather products such as welding gloves and welding clothing:

Type of leather	Features
Split cow leather	Heat & flame resistant, material breaths because of open structure, also low priced
Grain cow leather	Pliable and strong, water and oil resistant
Suede (reversed) pig leather	Soft and comfortable and mostly lower priced than other leathers
Grain deer leather	Fit and dexterity and, with that, very good comfort as well as water and oil resistant
Grain goat leather	Fit and dexterity, light weight and very good comfort as well as water and oil resistant
Grain bison leather	Fit and dexterity, very good comfort, high mechanical value as well as water and oil resistant

Leather grades and terminology:

Different portions of the hide of an animal have different characteristics: the side offers the best strength and most constant quality, the shoulder offers good strength and pliability, the belly is the lowest in quality but also the most economical.

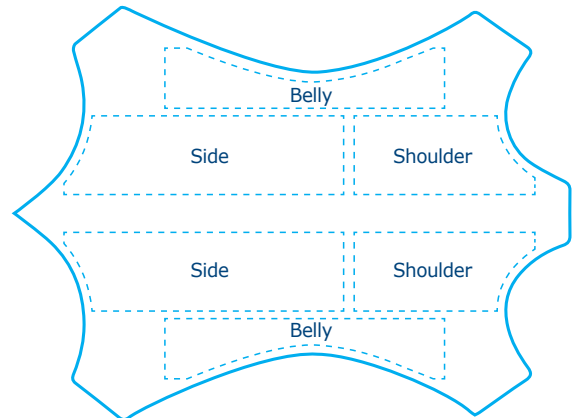
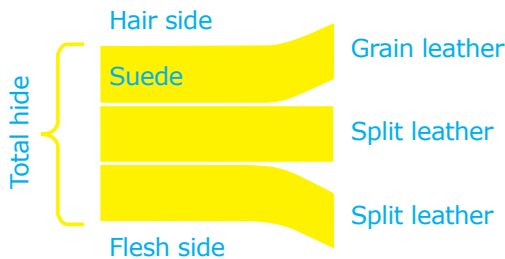

Choice of thumb design:

Straight thumb	Wing thumb	Keystone thumb
For extra sensitivity and/or extra welding gun grip	For seamless palm durability	For comfortable fit
<i>Note on thumb/palm design: extra durability and/or cut resistance can be achieved by adding an extra reinforcement around thumb and/or on palm of the glove.</i>		

Remark: the choice of materials and design for welding gloves and clothing but also for other products out of the Weldas product program always depend on what the applicable European norm desires. For that reason our products are tested and certified by a, by the European Union approved, test and certification laboratory. All test reports and certificates can be found on our special CE website:

www.weldas-ce.com

Weldas offers a lot of information through its catalog, website and other means of publication in order to help the user to make the right choice of product for its personal protection but it is and will always be the responsibility of the user what product he/she does choose.

INFORMATION ON EUROPEAN NORMS

In 1989 the council of the European community agreed on the directive 89/686/EEC which requires employers to use the appropriate personal protective equipment (PPE). As of April 21, 2018 the Regulation (EU) 2016/425 repealed the directive 89/686/EEC. All products used for personal protection must be marked with the appropriate basic CE marking and extended if the applicable norm does ask for it and according to its intended use. The regulation recognizes 3 levels of protection and the products to go with these levels:

Category I

Category I includes exclusively the following minimal risks:

- (a) superficial mechanical injury;
- (b) contact with cleaning materials of weak action or prolonged contact with water;
- (c) contact with hot surfaces not exceeding 50 °C;
- (d) damage to the eyes due to exposure to sunlight (other than during observation of the sun);
- (e) atmospheric conditions that are not of an extreme nature.

Category II

Category II includes risks other than those listed in Categories I and III;

Category III

Category III includes exclusively the risks that may cause very serious consequences such as death or irreversible damage to health relating to the following:

- (a) substances and mixtures which are hazardous to health;
- (b) atmospheres with oxygen deficiency;
- (c) harmful biological agents;
- (d) ionising radiation;
- (e) high-temperature environments the effects of which are comparable to those of an air temperature of at least 100 °C;
- (f) low-temperature environments the effects of which are comparable to those of an air temperature of – 50 °C or less;
- (g) falling from a height;
- (h) electric shock and live working;
- (i) drowning;
- (j) cuts by hand-held chainsaws;
- (k) high-pressure jets;
- (l) bullet wounds or knife stabs;
- (m) harmful noise.

Example of imprint of a Weldas® certified glove:

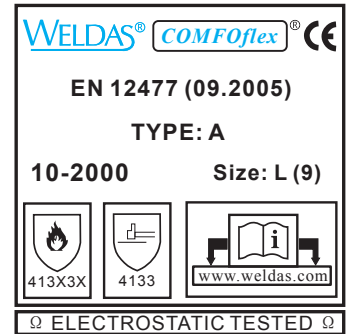

Basic norms and pictograms used for personal protection:

EN 420 norm on sizing of gloves: see page 9 of this catalogue.

EN 388 norm on mechanical risks for gloves:

Digit	Test Resistance	Level 1	Level 2	Level 3	Level 4	Level 5	
1st	Abrasion (# cycles)	100	500	2000	8000	-	
2nd	Blade Cut (index)	1,2	2,5	5,0	10,0	20,0	
3rd	Tear (Newton)	10	25	50	75	-	
4th	Puncture (Newton)	20	60	100	150	-	
5th	TDM Cut resistance (Newton)	A	B	C	D	E	F
		2	5	10	15	22	30

EN 407 norm thermal risks for gloves:

Digit	Test Resistance	Digit	Test Resistance
1st	Burning behaviour	5th	Small splashes of molten metal
2nd	Contact heat		
3rd	Convective heat	6th	Large quantities of molten metal
4th	Radiant heat		

EN 12477 norm on welding gloves and allied processes:

Minimum requirements	according to EN...	Type A Minimum Rating	Type B Minimum Rating
Electrical Insulation	pr1149-2	Rz10°Ω	Rz10°Ω
Abrasion Resistance	EN 388 2	500 cycles	100 cycles
Blade Cut Resistance	EN 388 1	Index 1,2	Index 1,2
Tear Resistance	EN 388 2	25 N	10 N
Puncture Resistance	EN 388 2	60 N	20 N
Burning Behaviour	EN 407 3		2
Contact Heat Resistance	EN 407 1	100° C	100° C
Convective Heat Resistance	EN 407 2	HTI≥7	0
Small Molten Splash Resistance	EN 407 3	25 Droplets	15 Droplets
Dexterity (pick up of rod dia.)	EN 420 1	≤11mm	≤6,5mm

EN 11611 norm on welding clothing and allied processes:

Requirement(s)	Class 1	Class 2
Tensile strength — woven outer textile material — leather		400 N 80 N
Tear strength		20 N
Dimensional change of woven textile materials Dimensional change of knitted textile materials		≤ ± 3 % ≤ ± 5 %
Flame spread * : For ISO 15025:2000, Procedure B, this requirement is not applicable.	ISO 15025:2000, Procedure A, (surface ignition) ; ISO 15025:2000, Procedure B, (edge ignition) No flaming to the top or either side edge; No hole formation a; No flaming or molten debris Mean afterflame ≤ 2 s; Mean afterglow ≤ 2 s	
Impact of spatter	15 drops	25 drops
Heat transfer (radiation)	RHTI 24 W 7	RHTI 24 W 16
Burst strength	200kPa	
Seam strength — textile material — leather	225 N 110 N	
Electrical resistance	>10°Ω	
Innocuousness	See 6.11	
Leather	Fat content: ≤ 15 %	



Weldas® Europe B.V.
Blankenweg 18
NL-4612 RC Bergen op Zoom
Holland

Tel.: +31 164 27 46 50
Fax: +31 164 27 46 55
europa@weldas.eu
www.weldas.com



WWW.WELDAS-CE.COM

KEVLAR® is a registered trademark of E.I. DuPont Co.
Weldas® is a registered trademark of Weldas® Company.
Arc Knight® is a registered trademark of Weldas® Co.
COMFOflex® is a registered trademark of Weldas® Co.
DEERSOsoft® is a registered trademark of Weldas® Co.
LAVAshield® is a registered trademark of Weldas® Co.
STEERSOuff® is a registered trademark of Weldas® Co.
SWEATSOpad® is a registered trademark of Weldas® Co.
TURMOflex® is a registered trademark of Weldas® Co.
Yellowjacket® is a registered trademark of Weldas® Co.
Arc Queen™ is a trademark of Weldas® Co.
COMBOframe™ is a trademark of Weldas® Co.
Fire Fox™ is a trademark of Weldas® Co.
Glove Medic™ is a trademark of Weldas® Co.
Golden Brown™ is a trademark of Weldas® Co.
Lava Brown™ is a trademark of Weldas® Co.
PYTHONrap™ is a trademark of Weldas® Co.
SOFTouch™ is a trademark of Weldas® Co.
ThunderingBison™ is a trademark of Weldas® Co.

©0219 Weldas® Europe B.V.
Printing and typesetting errors reserved.

YOUR DISTRIBUTOR:

